

## NEMO

Faretto a led ad alto rendimento per immersione permanente, disponibile sia nella versione monocromatica che RGB\*. Ghiera in acciaio AISI 316 o plastica stampata, equipaggiato con l'innovativo sistema DCS, una vetrocamera che consente un doppio isolamento del vano ottico. Corpo stagno in alluminio anodizzato completo di jack presa rapida; adatto all'installazione ad immersione in piscine o fontane.  
 (\*Gestione cambia colore mediante generatore di segnale ed elettronica non inclusa)

LED spotlight for high efficiency, available in both monochrome and RGB \* versions.  
 Ring in AISI 316 steel or moulded plastic, equipped with the innovative DCS system, a double-glazed unit that offers double insulation of the optical compartment. Full body in anodized aluminium complete with quick-set grip; suitable for immersion installation in swimming pools or fountains.  
 (\* Management changes colour via signal generator and electronics not included)

### DIMENSIONI / SIZE

Ø229,8mmx39mm

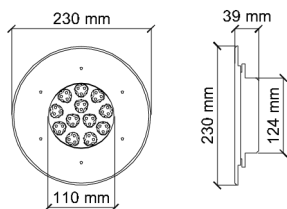

### MATERIALE / MATERIAL

Ghiera in acciaio AISI 316 marine o stampata in plastica  
 Steel ferrule Aisi 316L or Plastic moulded ferrule

### GRADO DI PROTEZIONE / LEVEL OF PROTECTION

IP 68, in conformità EN 60598-2-18  
 IP68 EN compliance to 60598-2-18

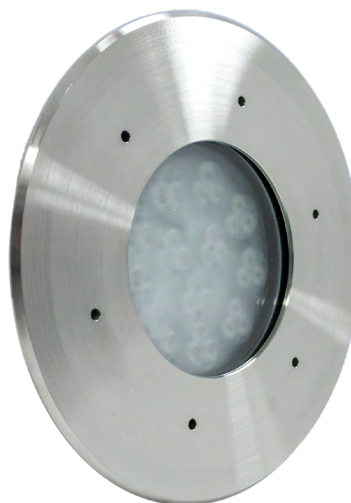

Link

Scheda montaggio  
 Installation instructions



Fotometrie  
 Photometries

### OTTICHE / OPTICS

0° 10° 25° 45°

### LUNGHEZZA CAVO / LEVEL OF PROTECTION

Apparecchio fornito con jack a presa rapida e 5 metri di cavo per immersione (2x0.50 o 4x0.50).

A richiesta misure di cavo maggiori (fornitura speciale)

Supplied with quick-release jack and 5 meters of immersion cable (2x0.50 or 4x0.50). Longer cable lengths on demand (special supply)

### INSTALLAZIONE / INSTALLATION

Disponibile con jack a presa rapida  
 Collegamento in parallelo con alimentazione 12V DC.  
 Alimentatore non incluso  
 Connection in parallel with quick hooking Jack.  
 Remote power pack not included 12V DC

### DATI ILLUMINOTECNICI ED ELETTRICI / LIGHTING AND ELECTRICAL DATA

**Parametri illuminotecnici elettrici ed ottici, secondo norma CEI EN 62722-2-1**  
**Electrical and optical lighting parameters, according to the CEI EN 62722-2-1 standard**

Sorgenti luminose	Light source	36 Led Seoul Z5
Temperatura di colore CCT	Color temperature CCT	3000K 4000K
Indice di resa cromatica Ra	Color Rendering coefficient Ra	>80
Deviazione cromatica Step MacAdam	Color deviation Step MacAdam	3
Flusso luminoso sorgente	Lumen light source	5077 lm
Flusso effettivo	Actual flux	3960 lm
Potenza	Power	45 W
Efficienza luminosa lm/W	Luminous efficiency lm/W	88 lm/W
Voltaggio*	Voltage**	12V DC
Temperatura di colore	Color temperature	RGB
Potenza	Power	45 W/m
Voltaggio*	Voltage**	12V DC
Temp.Tc@Ta 25°C	Temp.Tc@Ta 25°C	85°C
Temperatura standard ambiente esercizio:	Operating temperature	-20° +45°
Lifetime	Lifetime	L80 35.000h (Ta 25°C)

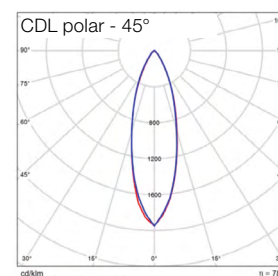
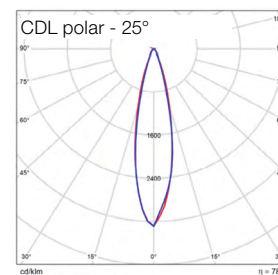
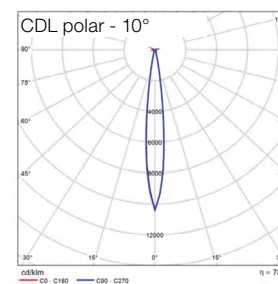

\*Alimentatori a tensione costante da ordinare separatamente disponibili sia IP20 che IP67 idonei per installazione in esterni. Disponibile interfaccia di dimmerazione DALI/DMX/0-10V/ 1-10V, per la versione monocromatica; PWM/DMX/DALI per RGB.  
Collegamenti tra alimentatore/strip led tramite cavi con connettori IP68 per la versione ad immersione.

\*\*Constant voltage ballasts to be ordered separately, both IP20 and IP67 are available and suitable for outdoor installation. DALI/DMX/0-10V/ 1-10V dimming interface available for monochromatic light; PWM/DMX/DALI for RGB  
The ballast and led strip are connected via cables with IP68 for immersion version

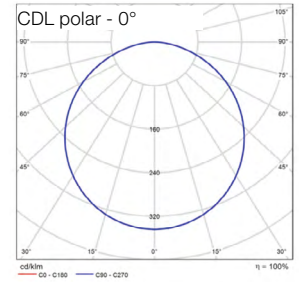

## ACCESSORI / ACCESSORIES

### INC NEMO

Controcassa in materiale plastico  
Dimensioni: Ø 207x95mm  
Recessed box made of plastic material  
Size: Ø 207x95mm

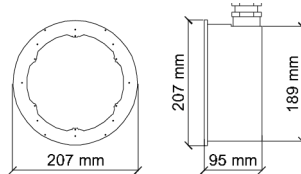

## ESPLOSO / EXPLODED

- 1 - Flangia Aisi 316
- 2 - Guarnizione nemo
- 3 - Vetro nemo Ø138 sp. 8mm
- 4 - Disco monosatinato nemo
- 5 - Lente micro trio
- 6 - Basetta 12x3.75W Seoul Z5 3k-4k-RGB
- 7 - Vite svasata M4x16 DIN933 Plastica
- 8 - Corpo spot
- 9 - Rondella in plastica Ø4.2x10x2 + viti in plastica M4X50 A4
- 10 - Pressacavo in plastica PG11
- 11 - Connettore MIL. maschio 14S

- 1 - Aisi 316 flange
- 2 - Gasket
- 3 - Glass Ø138 sp. 8mm
- 4 - Monosatin glass
- 5 - Micro trio lens
- 6 - Base led 2x3.75W Seoul Z5 3k-4k-RGB
- 7 - Countersunk screw M4x16 DIN933 Plastic
- 8 - Spot body
- 9 - Plastic washer Ø4.2x10x2 + plastic screws M4X50 A4
- 10 - Cable gland in plastic PG11
- 11 - Connettor MIL. 14St

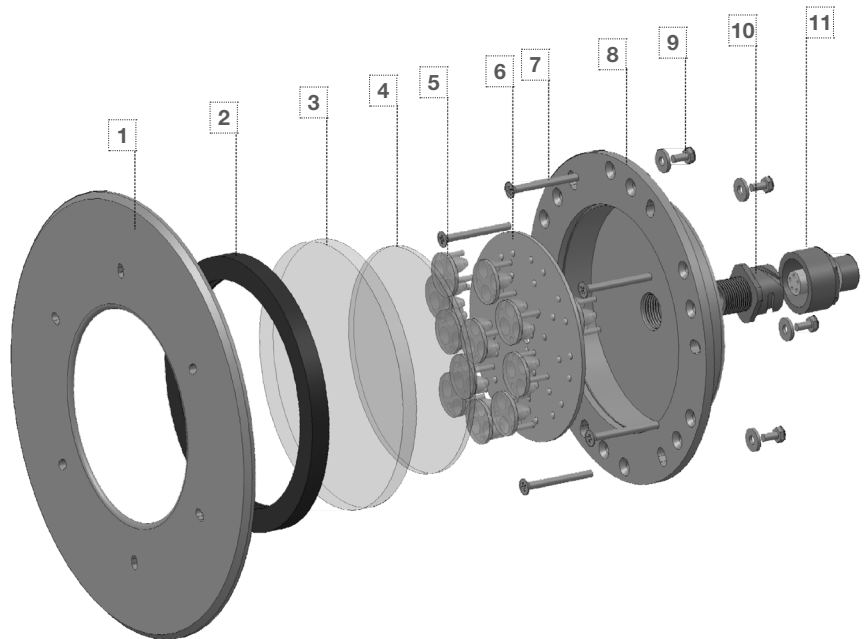

## ATTENZIONE / CAUTION

L'apparecchio deve essere utilizzato esclusivamente in immersione permanente.  
L'accensione del faretto fuori dall'acqua deve essere effettuata solamente per il tempo minimo necessario al test dell'impianto (2-3 minuti)

The appliance must only be used in permanent immersion.  
The lighting of the spotlight out of the water must be carried out only for the minimum time necessary for the system test (2-3 minutes)

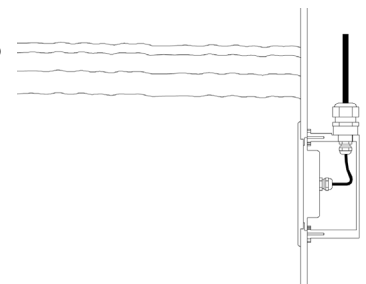

CERTIFICAZIONI / CERTIFICATIONS

- |  |  |
|--|--|
| <ul style="list-style-type: none"> <li>• Soddisfa EN60598-1 e relative note</li> <li>• CE - conforme EN 60598-1</li> <li>• Apparecchio calpestabile</li> <li>• Può essere installato su superfici infiammabili</li> <li>• Norma CEI 34-156 Classe di isolamento: III</li> <li>• Conforme alla direttive RAEE - D.lgs 49/2014</li> <li>• Norma CEI 64-8 e relativi varianti: prodotto può essere installato su superfici infiammabili</li> <li>• Conforme alla direttive RAEE - D.lgs 49/2014</li> <li>• IEC/EN 62471:2010 Rischio fotobiologico: RG 1</li> </ul> | <p>Satisfies EN60598-1 and related notes<br/>         CE - compliance to EN 60598-1<br/>         Walkable spotlights<br/>         It can be installed on surfaces that are normally flammable<br/>         CEI 34-156 Insulation class: III<br/>         Compliance to the directive RAEE - D.lgs 49/2014<br/>         CEI 34-156 Insulation class: ICEI 64-8 and variants: product can be installed on flammable surfaces<br/>         Compliance to the directive RAEE - D.lgs 49/2014<br/>         IEC/EN 62471:2010 Photobiological risk: RG 1</p> |
|--|--|

RESIN TEST REPORT

TEST	REF. METHOD	TEST CONDITIONS	RESULTS
<b>OUTDOOR RESISTANCE</b>			
Florida Test	SAE J 1976	Direct Inland ,45°South	Good (after 2 years )
Arizona Test	SAE J 1976	Direct Weathering, 45° South	Good (after 2 years )
Xenon WOM	SAE J 1960-89 2000h	65°C - cycle 102minUV + 18 min. UV/waterspray	No color change, minimal gloss change
Weatherometer QUV-B	SAE J 2020	1000h (8hUV 60°-4hcond.50°C)	No color change, minimal gloss change
Weatherometer QUV-A	SAE J 2020	2000h (8hUV 70°-4hcond.50°C)	No color change, minimal gloss change
<b>WATER AND CHEMICALS RESISTANCE</b>			
Fuel Resistance	G.M.6073	Immersion	No gloss change/No degradation
Acid Resistance	MS-CG12	Spot Test 0.5-10% conc.	No gloss change/No degradation
Solvent Resistance	GM 6121 M	Various types of used chemicals	No gloss change/No degradation
Water Immersion	WSK-M3G178	240 h.@ 45°C	No gloss change/No degradation
Salt Spray Resistance	ASTM B117-95	2000 h @38°C 5% NaCl	No gloss change/No degradation
Humidity Resistance	MS-CG12	250h @ 40°C 100% R.H.	No gloss change/No degradation
Environmental Cycle	G.M.6073	Three Cycles	No gloss change/No degradation
<b>HEAT RESISTANCE</b>			
Heat Resistance	MS-CG12	250 h @ 80°C	No gloss change/No degradation
High Temperature Resistance	G.M.6073	60 min. @ 93°C	No gloss change/No degradation
Thermal Shock	ESK-M99P16-A:3.5.5	16h. -40°C+ water@70°C/10cycles	No gloss change/No degradation
<b>ABRASION RESISTANCE</b>			
Stone Chip Resistance	SAE J400:85	0.47L of 250-300 graded gravel fired @ sample @480KPa in 5-10s	Chipping rating 10- No chipping to substrate
<b>FLAMMABILITY RESISTANCE</b>			
Flammability resistance	FMVSS 302	ISO 3795	Flame self extinguishing
<b>ELECTRICAL PROPERTIES</b>			
Surface Resistivity	ASTM D257	500 V – spec. thickness 2 mm	2 x 10E15 Ohm
Volume Resistivity	ASTM D257	500 V – spec. thickness 2 mm	1 x 10E15 Ohm cm

---

CODICI / CODE

Codice / Code	Ghiera / Ferrule	Ottica / Optic	T°K	Attacco / Connection
NEMO	X	0	30K	JK
NEMO	X	0	40K	JK
NEMO	X	0	RGB	JK
NEMO	X	10	30K	JK
NEMO	X	10	40K	JK
NEMO	X	10	RGB	JK
NEMO	X	25	30K	JK
NEMO	X	25	40K	JK
NEMO	X	25	RGB	JK
NEMO	X	45	30K	JK
NEMO	X	45	40K	JK
NEMO	X	45	RGB	JK
NEMO	P	0	30K	JK
NEMO	P	0	40K	JK
NEMO	P	0	RGB	JK
NEMO	P	10	30K	JK
NEMO	P	10	40K	JK
NEMO	P	10	RGB	JK
NEMO	P	25	30K	JK
NEMO	P	25	40K	JK
NEMO	P	25	RGB	JK
NEMO	P	45	30K	JK
NEMO	P	45	40K	JK
NEMO	P	45	RGB	JK

**Controcassa / Outercasing**

INC NEMO

---