

## SILJAN 3

Proiettori a led ad alto rendimento, realizzati in alluminio anodizzato, finitura Ral 7016 micaceo.

Il prodotto è fornito con base di fissaggio per plafone/applique, con alimentazione a 350mA o 230V, se associata con basi 230.

High performance led projectors, made in anodised aluminium, finishing Ral 7016 micaceous.

All products can be supplied with fastening base for ceiling/walls.

The spot is powered at 350mA, with the appropriate fixing base it can be powered at 230V AC.



### DIMENSIONI / SIZE

Spot: Ø 20mm x 50 mm

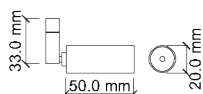

### OTTICHE / OPTICS

10° 25° 45°

### FINITURA / FINISHING

Verniciatura nero RAL 9005

Su richiesta disponibili altri colori della gamma RAL

Black Ral 9005

Upon request, other colors of the RAL range are available

### LUNGHEZZA CAVO / LEVEL OF PROTECTION

Apparecchio fornito con cavo 0.30 metri

Luminaire supplied with cable 0.30 meters

### INSTALLAZIONE / INSTALLATION

Installazione a parete, soffitto

Wall, ceiling installation

### GRADO DI PROTEZIONE / LEVEL OF PROTECTION

IP 20

## DATI ILLUMINOTECNICI ED ELETTRICI / LIGHTING AND ELECTRICAL DATA

### Parametri illuminotecnici elettrici ed ottici, secondo norma CEI EN 62722-2-1

### Electrical and optical lighting parameters, according to the CEI EN 62722-2-1 standard

Sorgenti luminose	Light source	<b>CREE XHP35</b>
Temperatura di colore CCT	Color temperature CCT	<b>3000K 4000K</b>
Indice di resa cromatica Ra	Color Rendering coefficient Ra	<b>&gt;90</b>
Deviazione cromatica Step MacAdam	Color deviation Step MacAdam	<b>3</b>
Flusso luminoso sorgente	Lumen light source	<b>410 lm</b>
Flusso effettivo	Actual flux	<b>344 lm</b>
Potenza	Power	<b>4 W</b>
Efficienza luminosa lm/W	Luminous efficiency lm/W	<b>86 lm/W</b>
Corrente di alimentazione*	Supply current**	<b>350mA</b>
Temp.Tc@Ta 25°C	Temp.Tc@Ta 25°C	<b>85°C</b>
Temperatura standard ambiente esercizio:	Operating temperature	<b>-20° +45°</b>
Lifetime	Lifetime	<b>L80 35.000h (Ta 25°C)</b>

\*Alimentatori a corrente costante da ordinare separatamente nella versione con FIX SLJ

\*\*Constant current driver to be ordered separately with FIX SLJ version

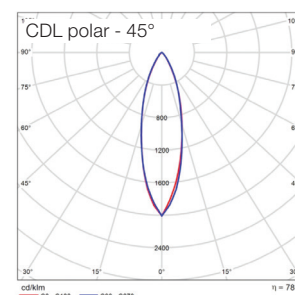
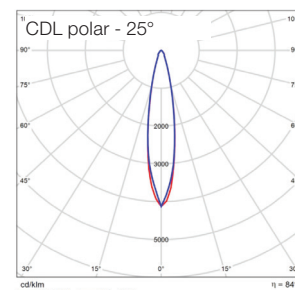
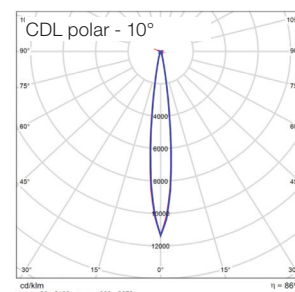

## ESPLOSO /EXPLODED

- 1 - Corpo spot
  - 2 - Lente Khatod esagonale
  - 3 - Led Xlamp XHP35
  - 4 - Dissipatore
  - 5 - Chiusura
  - 6 - Snodo in ottone 90° filettatura M8-M10-ØE13 mm
  - 7 - Adattatore M10-M8
  - 8 - Piedino fissaggio muro (FIX SLJ)
- 1 - Spot body
  - 2 - Khatod hexagonal lens
  - 3 - Led Xlamp XHP35
  - 4 - Heatsink
  - 5 - End cap
  - 6 - Brass joint 90° thread M8-M10-ØE13 mm
  - 7 - Adapter M10-M8
  - 8 - Wall fixing foot (FIX SLJ)

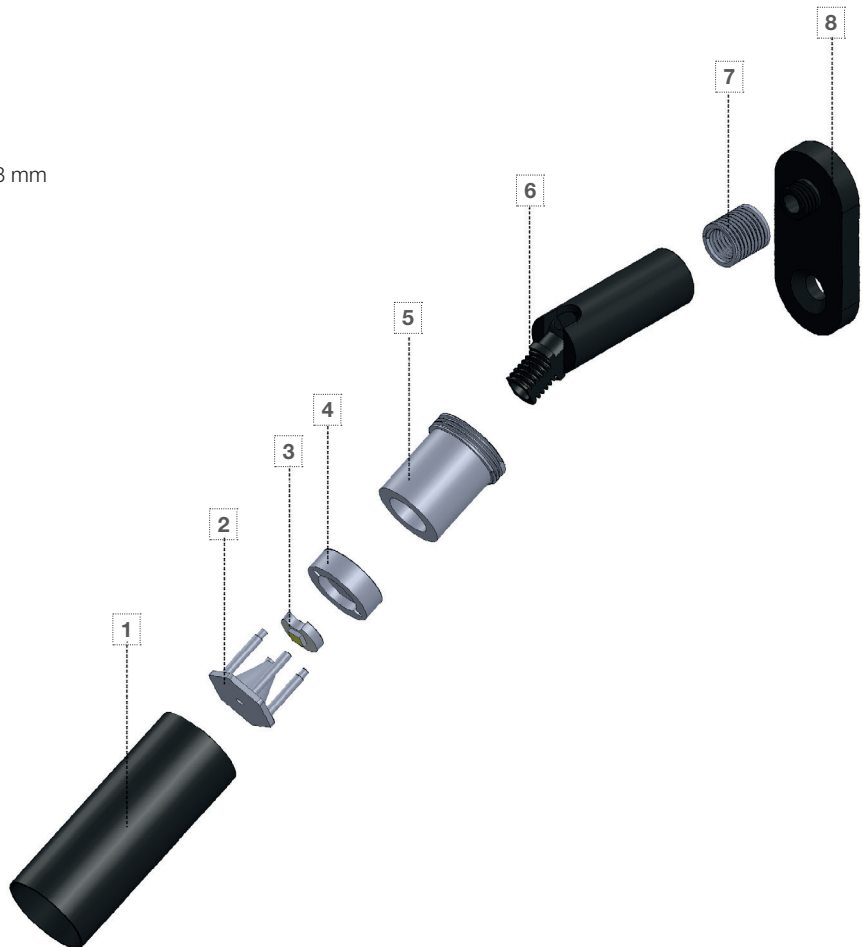

## ACCESSORI /ACCESSORIES

### FIX SLJ

Base di fissaggio per attacco plafone/applique  
 Dimensioni: 45x20x H5mm  
 Fixing base for Biko XS for ceiling or applique  
 Size: 45x20x H33mm

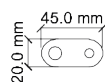

### CASE CV 350 230

Scatola per fissaggio completa di driver.  
 Alimentazione 230V AC.  
 Dimensioni: 100x70x H45mm  
 Fastening box complete with driver.  
 230V connection . Size: 100x70X H45mm

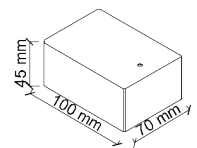

---

## CERTIFICAZIONI / CERTIFICATIONS

- Soddisfa EN60598-1 e relative note
  - CE - conforme EN 60598-1
  - Può essere installato su superfici infiammabili
  - Norma CEI 34-156 Classe di isolamento: III
  - Conforme alla direttive RAEE - D.lgs 49/2014
  - Norma CEI 64-8 e relativi varianti: prodotto può essere installato su superfici infiammabili
  - Conforme alla direttive RAEE - D.lgs 49/2014
  - IEC/EN 62471:2010 Rischio fotobiologico: RG 1
- Satisfies EN60598-1 and related notes  
CE - compliance to EN 60598-1  
It can be installed on surfaces that are normally flammable  
CEI 34-156 Insulation class: III  
Compliance to the directive RAEE - D.lgs 49/2014  
CEI 34-156 Insulation class: ICEI 64-8 and variants: product can be installed on flammable surfaces  
Compliance to the directive RAEE - D.lgs 49/2014  
IEC/EN 62471:2010 Photobiological risk: RG 1

---

## CODICI / CODES

<b>Codice / Code</b>	<b>Ottica / Optic</b>	<b>T°K</b>
SLJ 3 P	10	27K
SLJ 3 P	10	30K
SLJ 3 P	10	40K
SLJ 3 P	25	27K
SLJ 3 P	25	30K
SLJ 3 P	25	40K
SLJ 3 P	45	27K
SLJ 3 P	45	30K
SLJ 3 P	45	40K

### **Basi Fissaggio / Fixing bases**

FIX SLJ

CASE CV 350 230